



education

Department:
Education
REPUBLIC OF SOUTH AFRICA

**NATIONAL
SENIOR CERTIFICATE**

GRADE/GRAAD 12

**PHYSICAL SCIENCES: CHEMISTRY (P2)
FISIESE WETENSKAPPE: CHEMIE (V2)**

MEMORANDUM

FEBRUARY/FEBRUARIE/MARCH/MAART 2010

MARKS/PUNTE: 150

**This memorandum consists of 20 pages.
*Hierdie memorandum bestaan uit 20 bladsye.***

Learning Outcomes and Assessment Standards Leeruitkomst en Assesseringstandaarde		
LO 1/LU 1	LO 2/LU 2	LO 3/LU 3
<p>AS 12.1.1: Design, plan and conduct a scientific inquiry to collect data systematically with regard to accuracy, reliability and the need to control variables.</p> <p><i>Ontwerp, beplan en voer 'n wetenskaplike ondersoek uit om data te versamel ten opsigte van akkuraatheid, betroubaarheid en die kontroleer van veranderlikes.</i></p> <p>AS 12.1.2: Seek patterns and trends, represent them in different forms, explain the trends, use scientific reasoning to draw and evaluate conclusions, and formulate generalisations.</p> <p><i>Soek patrone en tendense, stel dit in verskillende vorms voor, verduidelik tendense, gebruik wetenskaplike beredenering om gevolgtrekkings te maak en te evalueer, en formuleer veralgemenings.</i></p> <p>AS 12.1.3: Select and use appropriate problem-solving strategies to solve (unseen) problems.</p> <p><i>Kies en gebruik geskikte probleemoplossingsstrategieë om (ongesiene) probleme op te los.</i></p> <p>AS 12.1.4: Communicate and defend scientific arguments with clarity and precision.</p> <p><i>Kommunikeer en verdedig wetenskaplike argumente duidelik en presies.</i></p>	<p>AS 12.2.1: Define, discuss and explain prescribed scientific knowledge.</p> <p><i>Definieer, bespreek en verduidelik voorgeskrewe wetenskaplike kennis.</i></p> <p>AS 12.2.2 Express and explain prescribed scientific principles, theories, models and laws by indicating the relationship between different facts and concepts in own words.</p> <p><i>Verduidelik en druk voorgeskrewe wetenskaplike beginsels, teorieë, modelle en wette uit deur die verwantskap tussen verskillende feite konsepte in eie woorde aan te dui.</i></p> <p>AS 12.2.3: Apply scientific knowledge in everyday life contexts.</p> <p><i>Pas wetenskaplike kennis in kontekste van die alledaagse lewe toe.</i></p>	<p>AS 12.3.1: Research, discuss, compare and evaluate scientific and indigenous knowledge systems and knowledge claims by indicating the correlation among them, and explain the acceptance of different claims.</p> <p><i>Doen navorsing, bespreek, vergelyk en evalueer wetenskaplike en inheemse kennisisteme en kennis aansprake deur die ooreenkoms aan te dui en verduidelik die aanvaarding van verskillende aansprake.</i></p> <p>AS 12.3.2: Research case studies and present ethical and moral arguments from different perspectives to indicate the impact (pros and cons) of different scientific and technological applications.</p> <p><i>Vors gevallestudies na en lewer etiese en morele argumente uit verskillende perspektiewe om die impak (voordele en nadele) van verskillende wetenskaplike en tegnologiese toepassings aan te dui.</i></p> <p>AS 12.3.3: Evaluate the impact of scientific and technological research and indicate the contribution to the management, utilisation and development of resources to ensure sustainability continentally and globally.</p> <p><i>Evalueer die impak van wetenskaplike en tegnologiese navorsing en dui die bydrae tot bestuur, benutting en ontwikkeling van bronne om volhoubaarheid kontinentaal en globaal te verseker</i></p>

GENERAL GUIDELINES/ALGEMENE RIGLYNE

1. CALCULATIONS/BEREKENINGE

- 1.1 Marks will be awarded for: correct formula, correct substitution, correct answer with unit.
Punte sal toegeken word vir: korrekte formule, korrekte substitusie, korrekte antwoord met eenheid.
- 1.2 No marks will be awarded if an incorrect or inappropriate formula is used, even though there may be relevant symbols and applicable substitutions.
Geen punte sal toegeken word waar 'n verkeerde of ontoepaslike formule gebruik word nie, selfs al is daar relevante simbole en relevante substitusies.
- 1.3 When an error is made during **substitution into a correct formula**, a mark will be awarded for the correct formula and for the correct substitutions, but **no further marks** will be given.
*Wanneer 'n fout gedurende **substitusie in 'n korrekte formule** begaan word, sal 'n punt vir die korrekte formule en vir korrekte substitusies toegeken word, maar **geen verdere punte** sal toegeken word nie.*
- 1.4 If no formula is given, but all substitutions are correct, a candidate will forfeit one mark. Indien geen *formule* gegee is nie, maar al die *substitusies* is korrek, verloor die kandidaat een punt.

Example/Voorbeeld:

No K_c expression, correct substitution/*Geen K_c -waarde, korrekte substitusie*

$$K_c = \frac{(2)^2}{(2)(1)^3} \checkmark = 2 \checkmark \left(\frac{2}{3}\right)$$

- 1.5 Marks can only be allocated for substitutions when values are substituted into formulae and not when listed before a calculation starts.
Punte kan slegs toegeken word vir substitusies wanneer waardes in formule ingestel is en nie vir waardes wat voor 'n berekening gelys is nie.
- 1.6 All calculations, when not specified in the question, must be done to two decimal places.
Alle berekenings, wanneer nie in die vraag gespesifiseer word nie, moet tot twee desimale plekke gedoen word.

2. DEFINITIONS/DEFINISIES

Two marks will be awarded for a correct definition. No marks will be awarded for an incorrect or partially correct definition.

Twee punte sal vir 'n korrekte definisie toegeken word. Geen punte sal vir 'n verkeerde of gedeeltelik korrekte definisie toegeken word nie.

3. UNITS/EENHEDE

- 3.1 Candidates will only be penalised once for the repeated use of an incorrect unit **within a question or sub-question.**

'n Kandidate sal slegs een keer gepenaliseer word vir die herhaaldelike gebruik van 'n verkeerde eenheid in 'n vraag of subvraag.

- 3.2 Units are only required in the final answer to a calculation.

Eenhede word slegs in die finale antwoord tot 'n vraag verlang.

- 3.3 Marks are only awarded for an answer, and not for a unit *per se*. Candidates will therefore forfeit the mark allocated for the answer in each of the following situations:

- Correct answer + wrong unit
- Wrong answer + correct unit
- Correct answer + no unit.

Punte word slegs vir 'n antwoord en nie vir 'n eenheid per se toegeken nie. Kandidate sal derhalwe die punt vir die antwoord in die volgende gevalle verbeur:

- Korrekte antwoord + verkeerde eenheid
- Verkeerde antwoord + korrekte eenheid
- Korrekte antwoord + geen eenheid

- 3.4 Separate compound units with a multiplication dot, not a full stop, for example, mol·dm⁻³. For marking purposes mol.dm⁻³ (or mol/dm³) will also be accepted *Skei saamgestelde eenhede met 'n vermenigvuldigpunt en nie met 'n punt nie, byvoorbeeld, mol·dm⁻³. Vir nasiendoeleindes sal mol.dm⁻³ (of mol/dm³) ook aanvaar word.*

4. GENERAL/ALGEMEEN

- 4.1 If one answer or calculation is required, but two given by the candidate, only the first one will be marked, irrespective of which one is correct. If two answers are required, only the first two will be marked, etc.

Indien een antwoord of berekening verlang word, maar twee word deur die kandidaat gegee, sal slegs die eerste een nagesien word, ongeag watter een korrek is. Indien twee antwoorde verlang word, sal slegs die eerste twee nagesien word, ens.

- 4.2 When a chemical **FORMULA** is asked, and the **NAME** is given as answer, only one of the two marks will be awarded. The same rule applies when the **NAME** is asked and the **FORMULA** is given.

*Wanneer 'n chemiese **FORMULE** gevra word en die **NAAM** word as antwoord gegee, sal slegs een van die twee punte toegeken word. Dieselfde reël geld wanneer die **NAAM** gevra word en die **FORMULE** gegee word.*

- 4.3 When redox half-reactions are to be written, the correct arrow should be used. If the equation

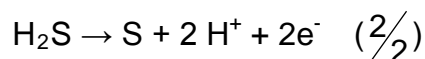

is the correct answer, the following marks will be given:

Wanneer redokshalfreaksies geskryf moet word, moet die korrekte pyltjie gebruik word. Indien die vergelyking die korrekte antwoord is, sal die volgende punte toegeken word:

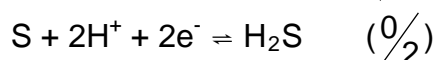
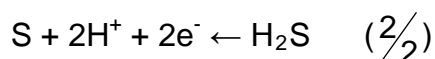
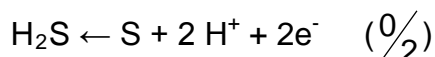
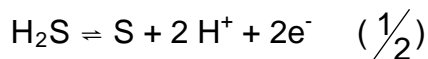

- 4.4 When candidates are required to give an explanation involving the relative strength of oxidising and reducing agents, the following is unacceptable:

- Stating the position of a substance on table 4 only (e.g. Cu is above Mg).
- Using relative reactivity only (e.g. Mg is more reactive than Cu).
- The correct answer would for instance be: Mg is a stronger reducing agent than Cu, and therefore Mg will be able to reduce Cu^{2+} ions to Cu. The answer can also be given in terms of the relative strength as electron acceptors and donors.

Wanneer kandidate 'n verduideliking moet gee oor die relatiewe sterkte van oksideer- en reduseermiddels, is die volgende onaanvaarbaar:

- *Meld slegs die posisie van 'n stof op tabel 4 (bv. Cu is bo Mg).*
- *Gebruik slegs relatiewe reaktiwiteit (bv. Mg is meer reaktief as Cu).*
- *Die korrekte antwoord sal byvoorbeeld wees: Mg is 'n sterker reduseermiddel as Cu en derhalwe sal Mg in staat wees om Cu^{2+} -ione na Cu te reduseer. Die antwoord kan ook in terme van die relatiewe sterkte van elektronakseptors of donors gegee word.*

- 4.5 One mark will be forfeited when the charge of an ion is omitted per equation.

Een punt sal verbeur word wanneer die lading van 'n ioon per vraag weggelaat is.

- 4.6 The error carrying principle does not apply to chemical equations or half reactions. For example, if a learner writes the wrong oxidation/reduction half-reaction in the sub-question and carries the answer to another sub-question (balancing of equations or calculation of $E_{\text{cell}}^{\ominus}$) then the learner is not credited for this substitution.

Die foutdraendebeginsel geld nie vir chemiese vergelykings of halfreaksies nie. Byvoorbeeld, indien 'n leerder die verkeerde oksidasie/reduksie-halfreaksie vir die subvraag skryf en die antwoord na 'n ander subvraag dra (balansering van vergelyking of E_{sel}^{\ominus}) dan word die leerder nie vir die substitusie gekrediteer nie.

- 4.7 In the structural formula of an organic molecule all hydrogen atoms must be shown. Marks will be deducted if hydrogen atoms are omitted.

In die struktuurformules van 'n organiese molekule moet alle waterstofatome getoon word. Punte sal afgetrek word vir die weglating van waterstofatome.

- 4.8 When a structural formula is asked, marks will be deducted if the learner writes the condensed formula./Wanneer 'n struktuurformule gevra word, sal punte afgetrek word indien die leerder die gekondenseerde formule skryf.
- 4.9 When an IUPAC name is asked and the candidate omits the hyphen (e.g. instead of pent-1-ene or 1-pentene the candidate writes pent 1 ene or 1 pentene), marks will be forfeited.
Wanneer die IUPAC naam gevra word en die koppelteken(s) in die naam word uitgelaat (bv. in plaas van pent-1-ene of 1 -penteen skryf 'n kandidaat pent 1 een of 1 penteen), sal punte verbeur word.
- 4.10 When a chemical reaction is asked, marks are awarded for correct reactants, correct products and correct balancing. Wanneer 'n chemiese reaksie gevra word, word punte toegeken vir korrekte reaktanse, korrekte produkte en korrekte balansering.

If only a reactant(s) followed by an arrow, or only a product(s) preceded by an arrow, is/are written, marks may be awarded for the reactant(s) or product(s). If only a reactant(s) or only a product(s) are written, without an arrow, no marks are awarded for the reactant(s) or product(s). Indien slegs 'n reaktans(e) gevolg deur 'n pyl, of slegs 'n produk(te) voorafgegaan deur 'n pyl, geskryf word, word punte vir die reaktans(e) of produkte gegee. Indien slegs reaktanse of slegs produk(te) geskryf word sonder 'n pyl, word geen punte gegee nie.

Examples/Voorbeelde: $N_2 + 3H_2 \checkmark \rightarrow NH_3 \checkmark$ bal. \checkmark

$N_2 + 3H_2 \rightarrow \checkmark$ $\frac{1}{3}$

$\rightarrow NH_3 \checkmark$ $\frac{1}{3}$

$N_2 + 3H_2$ $\frac{0}{3}$

NH_3 $\frac{0}{3}$

5. POSITIVE MARKING / POSITIEWE NASIEN

Positive marking regarding calculations will be followed in the following cases:
Positiewe nasien met betrekking tot berekenings sal in die volgende gevalle geld:

- 5.1 **Sub-question to sub-question:** When a certain variable is calculated in one sub-question (e.g. 3.1) and needs to be substituted in another (3.2 or 3.3), e.g. if the answer for 3.1 is incorrect and is substituted correctly in 3.2 or 3.3, **full marks** are to be awarded for the subsequent sub-questions.

Subvraag na subvraag: Wanneer 'n sekere veranderlike in een subvraag (bv. 3.1) bereken word en dan in 'n ander vervang moet word (3.2 of 3.3), bv. indien die antwoord vir 3.1 verkeerd is en word korrek in 3.2 of 3.3 vervang, word **volpunte** aan die daaropvolgende subvraag toegeken

- 5.2 **A multi-step question in a sub-question:** If the candidate has to calculate, for example, number of moles in the first step and gets it wrong due to a substitution error, the mark for the substitution and the final answer will be forfeited.
'n Vraag met veelvuldige stappe in 'n subvraag: *Indien 'n kandidaat byvoorbeeld, die aantal mol verkeerd bereken in 'n eerste stap as gevolg van 'n substitusiefout, verloor die kandidaat die punt vir die substitusie sowel as die finale antwoord.*
- 5.3 If a final answer to a calculation is correct, full marks will not automatically be awarded. Markers will always ensure that the correct/appropriate formula is used and that workings, including substitutions, are correct.
Indien 'n finale antwoord tot 'n berekening korrek is, sal volpunte nie outomaties toegeken word nie. Nasieners sal altyd verseker dat die korrekte/toepaslike formule gebruik word en dat bewerkings, insluitende substitusies korrek is.

SECTION A/AFDELING A

QUESTION 1/VRAAG 1

- 1.1 Activation energy / *Aktiveringsenergie* ✓ [12.2.1] (1)
1.2 Homogeneous / *Homogeen* ✓ [12.2.1] (1)
1.3 Oxidising agent / *Oksideermiddel* [12.2.1] (1)
1.4 Secondary / *Sekondêre* ✓ [12.2.1] (1)
1.5 Dehydrohalogenation / *Dehidrohalogenering* ✓ [12.2.1] (1)
[5]

QUESTION 2/VRAAG 2

- 2.1 The (cyclo)alkanes is the homologous series ... ✓✓
Die (siklo)alkane is die homoloë reeks ...
OR/OF
... homologous series to which benzene/(any arene belongs).
... homoloë reeks waartoe benseen/(enige areen behoort) [12.2.3] (2)
2.2 ... average kinetic energy .../... *gemiddelde kinetiese energie* ... ✓✓ [12.2.1] (2)
2.3 ... is equal to $\frac{1}{K}$ / ... *is gelyk aan* $\frac{1}{K}$ ✓✓
OR/OF
... less (smaller) than K/... *minder (kleiner) as K.* [12.2.2] (2)
2.4 Ions flow.../ *ione vloei*... ✓✓
OR/OF
Electrons flow through the external circuit.../ *Elektrone vloei deur die eksterne stroombaan* ... [12.2.2] (2)
2.5 ... (100 x 3600) C / $3,6 \times 10^5$ C ✓✓ [12.2.3] (2)
[10]

QUESTION 3/VRAAG 3

- 3.1 C ✓✓ [12.2.3] (2)
3.2 B ✓✓ [12.2.3] (2)
3.3 B ✓✓ [12.1.2] (2)
3.4 D ✓✓ [12.2.3] (2)
3.5 C ✓✓ [12.2.1] (2)
[10]

TOTAL SECTION A: 25
TOTAAL AFDELING A: 25

SECTION B/*AFDELING B*

QUESTION 4/*VRAAG 4*

4.1	Ketones/ <i>Ketone</i> ✓	[12.2.1]	(1)
4.2	Butane/ <i>Butaan</i> ✓	[12.2.3]	(1)
4.3	Haloalkane/ <i>Haloalkaan</i> ✓	[12.2.1]	(1)
4.4	Aldehydes/ <i>Aldehiede</i> ✓	[12.2.3]	(1)
4.5	Haloalkane/ <i>Haloalkaan</i> ✓	[12.2.3]	(1)
4.6	Hydrolysis/ <i>Hidrolise</i> ✓	[12.2.3]	(1)
4.7	Amines/ <i>Amiene</i> ✓	[12.2.1]	(1)
4.8	But-1-ene/ <i>But-1-een</i> ✓	[12.2.3]	(1)
4.9	Ethyne/ <i>Etyn</i> ✓	[12.2.1]	(1)
4.10	Hydrohalogenation/ <i>Hidrohalogenering</i> ✓	[12.2.3]	(1)

[10]

QUESTION 5/*VRAAG 5*

5.1	An (organic) compound that consists of hydrogen and carbon only. ✓✓ <i>'n (Organiese) verbinding wat slegs uit koolstof en waterstof bestaan.</i> ✓✓	Only/Slegs $\frac{2}{2}$ or/of $\frac{0}{2}$	[12.2.1]	(2)
5.2	CO ₂ ✓ H ₂ O ✓		[12.2.3]	(2)

5.3

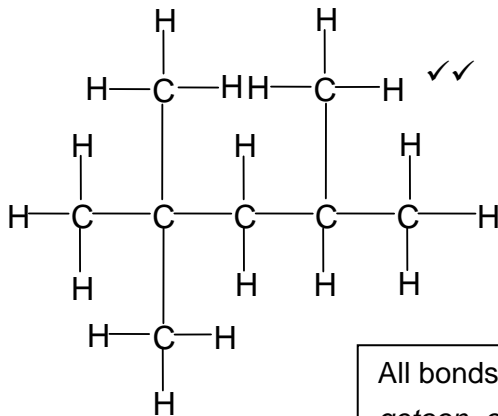

Condensed or semi-structural formula / *Gekondenseerde of semi-struktuurformule*: Max./Maks $\frac{1}{2}$
e.g./bv.

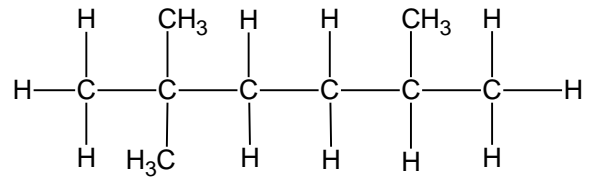

All bonds shown, one or more H atoms omitted / *Alle bindinge getoon, een of meer H-atome uitgelaat*: Max./Maks. $\frac{1}{2}$

Molecular formula / *Molekulêre formule*: $\frac{0}{2}$

[12.2.3] (2)

5.4

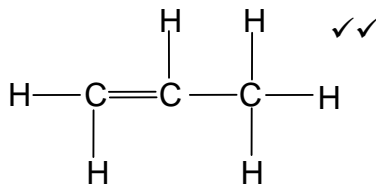

prop-1-ene / *prop-1-een* ✓

Condensed or semi-structural formula / *Gekondenseerde of semistruktuurformule*: Max./Maks. $\frac{2}{3}$
e.g./bv.

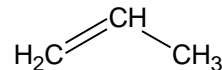

All bonds shown, one or more H atoms omitted / *Alle bindinge getoon, een of meer H-atome uitgelaat*:
Max./Maks. $\frac{2}{3}$

Molecular formula / *Molekulêre formule*: Max./Maks. $\frac{1}{3}$

Accept: 1-propene / propene
Aanvaar: 1-propeen / propeen

Hyphen(s) omitted / *Koppelteken(s) uitgelaat*: Max./Maks. $\frac{2}{3}$

[12.2.3] (3)
[9]

QUESTION 6/VRAAG 6

6.1 Alcohols/Alkohole ✓

[12.2.1] (1)

6.2

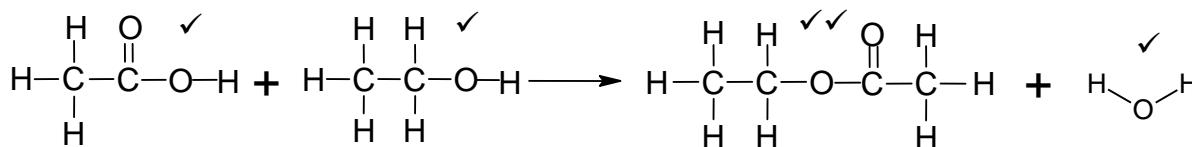

Marking rule 4.10
Nasienreël 4.10

Accept / Aanvaar: -OH & H₂O as condensed/gekondenseerd

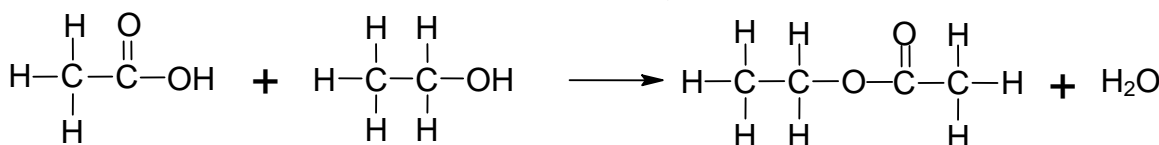

Condensed/semi-structural formulae or mixture of both / **Gekondenseerde / semistruktuur formules** of mengsel van beide: Max./Maks. 4/5

E.g./Bv. CH₃ – COOH / CH₃COOH / CH₃CH₂OH

Everything correct, **wrong balancing** / *Alles korrek, verkeerde balansering*: Max./Maks. 4/5

All bonds shown, one or more **H atoms omitted** / *Alle bindinge getoon, een of meer H-atome uitgelaat*:
- 1 per structure / per struktuur

Molecular formula for all structures/ **Molekulêre formules** vir alle strukture.

E.g./Bv. C₂H₄O₂ Max./Maks. 1/5

Any additional reactant(s) or product(s)/ *Enige addisionele reaktant(e) of produk(te)*: Max./Maks. 4/5

If H atom of –OH attached to C atom: no marks for structure
Indien H-atoom van –OH geheg aan C-atoom: geen punte vir struktuur

If more than 4 bonds formed to C atom: no marks for structure
Indien meer as 4 bindinge gevorm na C-atoom: geen punte vir struktuur

[12.2.3] (5)

6.3 Catalyst / Katalisator ✓

[12.2.1] (1)

6.4 Ethanol is flammable. / Etanol is vlambaar. ✓

[12.1.1] (1)

- 6.5 Vapours are cooled down and condense / return to the test tube. ✓
Dampe word afgekoel en kondenseer / keer terug na die proefbuis.

OR/OF

Prevents vapours from leaving the test tube. / Verhoed dat dampe die proefbuis verlaat.

OR/OF

Functions as a condenser. / Tree op as 'n kondensator.

OR/OF

Causes mixture to reflux.

Veroorsaak dat die mengsel onder terugvloei verhit word.

[12.1.1] (1)

- 6.6 Sodium carbonate solution is a base ✓ and will neutralise both acids, ✓ preventing them from masking the smell of the ester.

Natriumkarbonaatoplossing is 'n basis ✓ en sal

beide sure neutraliseer ✓ wat verhoed dat die ester geruik word.

[12.2.3] (2)

- 6.7 Vapour pressure / dampdruk ✓

OR/OF

Boiling point / kookpunt

OR/OF

Volatility / vlugtigheid

[12.2.2] (1)
[12]

QUESTION 7/VRAAG 7

7.1.1

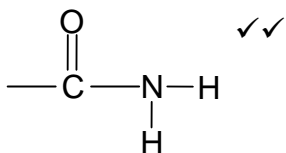

Molecular formula /
Molekulêre formule: $\frac{0}{2}$

Condensed or semi-structural formula / *Gekondenseerde of semistruktuurformule*: Max./Maks. $\frac{1}{2}$

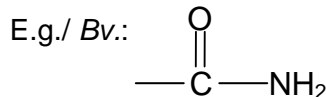

[12.2.1] (2)

7.1.2

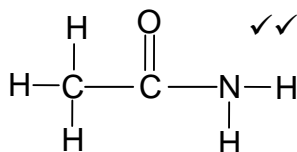

Condensed or semi-structural formula / *Gekondenseerde of semistruktuurformule*: Max./Maks. $\frac{1}{2}$

E.g./ Bv.:

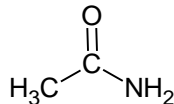

Molecular formula /
Molekulêre formule: $\frac{0}{2}$

All bonds shown, one or more H atoms omitted / *Alle bindinge getoon, een of meer H-atome uitgelaat*:
Max./Maks. $\frac{1}{2}$

[12.2.3] (2)

- 7.2 The nitrogen atom is bonded to one other alkyl group/C-group. ✓
Die stikstofatoom is aan een ander alkielgroep/C-groep gebind.

[12.2.3] (1)

- 7.3.1 Chain length increases with increase in molecular mass (of straight chain hydrocarbons.) ✓
Van der Waals forces increases with increase in chain length. ✓

Kettinglengte neem toe met toename in molekulêre massa (van reguitketting koolwaterstowwe.) ✓

Van der Waalskragte neem toe met toename in kettinglengte. ✓

[12.2.2] (2)

- 7.3.2 Boiling points of amides decrease with increase in molecular mass. ✓✓
Kookpunte van amiede neem af met toename in molekulêre massa.

[12.1.2] (2)

- 7.3.3
- Ethanamide (primary amide, smallest molecular mass):
most hydrogen bonding (two sites for hydrogen bonding), highest boiling point. ✓
 - N,N-dimethylethanamide (tertiary amide, biggest molecular mass):
no hydrogen bonding, only weak Van der Waals forces, lowest boiling point. ✓
 - N-methylethanamide (secondary amide, molecular mass between the above two amides):
one site for hydrogen bonding, boiling point between the above two amides (closer to that of primary amide due to H bonding.) ✓
 - Etaanamied (*primêre amied, kleinste molekulêre massa*):
meeste waterstofbinding (twee punte vir waterstofbinding), hoogste kookpunt. ✓
 - N,N-dimetieletaanamied (*tersiêre amied, grootste molekulêre massa*):
geen waterstofbinding, slegs swak Van der Waalskragte, laagste kookpunt. ✓
 - N-metieletaanamied (*sekondêre amied, molekulêre massa tussen die twee bogenoemde amiede*):
een moontlikheid vir waterstofbinding, kookpunt tussen die twee amiede (nader aan die van primêre amied weens H-binding). ✓

[12.2.2] (3)

- 7.3.4 Only the molecular mass will change. ✓
The number of H bonds will remain the same. ✓
(It will be a better indication of the relationship between mass and boiling points.)

*Slegs die molekulêre massa sal dan verander. ✓
Die aantal H-bindinge sal dieselfde bly. ✓
(Dit sal 'n beter aanduiding van die verwantskap tussen ,oelkulêre massa en kookpunt wees.)*

OR/OF

There will then be only one independent variable (molecular mass) ✓
and not two (molecular mass and number of H bonds) as in the current investigation.) ✓

*Daar sal dan slegs een onafhanklike veranderlike (molekulêre massa) ✓ wees en
nie twee (molekulêre massa en aantal H-bindinge) soos in die huidige eksperiment nie. ✓*

[12.1.2] (2)
[14]

QUESTION 8/VRAAG 8

- 8.1 Any two / Enige twee:

- Burning of fuel when cars are used - exhaust gases contains oxides of nitrogen. ✓
Verbranding van brandstof wanneer motors gebruik word – uitlaatgasse bevat oksiede van stikstof.
- Burning of coal (generation of electricity)/nitrogen containing compounds/organic waste. ✓
Verbranding van steenkool (opwek van elektrisiteit)/stikstofbevattende verbindings/organiese afval.
- Factories and other industrial plants that emits nitrogen oxides into the atmosphere as waste.
Fabrieke en ander industriële aanlegte wat stikstofoksiede in die atmosfeer as afval vrystel.

[12.3.2] (2)

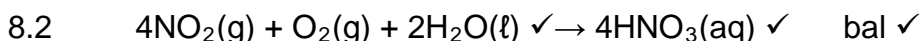

OR/OF



[12.2.3] (3)

- 8.3 $\text{NO}_2(\text{g})$ dissolves in rainwater to form acid rain that burns/destroys crops. ✓

$\text{NO}_2(\text{g})$ los op in reënwater om suurreën te vorm wat gewasse brand/beskadig.

[12.3.2] (1)

- 8.4 NO_3^- (aq) is a strong oxidising agent ✓
and oxidise Cu (to Cu^{2+}). ✓
 H^+ (aq) is not a strong enough oxidising agent ✓ and cannot oxidise Cu
to Cu^{2+} .

NO_3^- (aq) is 'n sterk oksideermiddel ✓
en oksideer Cu (na Cu^{2+}). ✓

H^+ (aq) is nie 'n sterk genoeg oksideermiddel nie ✓ en kan nie Cu na
 Cu^{2+} te oksideer nie.

[12.2.3] (3)

8.5.1

	2NO_2	N_2O_4
Initial number of mole (mol) <i>Aanvanklike aantal mol (mol)</i>	2	x
Number of moles used/formed (mol) <i>Aantal mol gereageer/gevorm</i>	-1,2 ✓	+0,6 ✓
Number of moles at equilibrium (mol) <i>Aantal mol by ewewig (mol)</i>	0,8 ✓	x + 0,6 ✓
Equilibrium concentration ($\text{mol}\cdot\text{dm}^{-3}$) <i>Ewewigskonsentrasie ($\text{mol}\cdot\text{dm}^{-3}$)</i>	0,4	$\frac{x + 0,6}{2}$ ✓

$$K_c = \frac{[\text{N}_2\text{O}_4]}{[\text{NO}_2]^2} \checkmark \therefore 2 \checkmark = \frac{\left(\frac{x + 0,6}{2}\right)}{(0,4)^2} \checkmark \therefore x = 0,04 \text{ mol}\cdot\checkmark$$

[12.1.3] (9)

- 8.5.2 Decreases / Verminder ✓

[12.2.3] (1)

- 8.5.3 When the pressure is increased the system will try to decrease the
pressure. ✓

The forward reaction (2 mol to 1 mol) is favoured. ✓

Expressions with the same meaning as “forward reaction is favoured”:
Equilibrium position shifts to the right. / Equilibrium lies to the right.
Accept: The equilibrium shifts to the right.

Wanneer die druk verhoog word, sal die sisteem poog om die druk te
verlaag. ✓

Die voorwaartse reaksie word bevoordeel (2 mol na 1 mol).

Uitdrukkings met dieselfde betekenis as “voorwaartse reaksie bevoordeel”:
Ewewigsposisie skuif na regs. / Ewewigsposisie lê na regs.
Aanvaar: Die ewewig skuif na regs.

[12.2.3] (2)

[21]

QUESTION 9/VRAAG 9

9.1 The change in amount/mass/volume of products formed per unit time.
Die verandering in die hoeveelheid/massa/volume van produkte gevorm per eenheidstyd.

OR/OF

The change in amount/mass/volume of reactants used per unit time.
Die verandering in die hoeveelheid/massa/volume van reaktanse gebruik per eenheidstyd.

[12.2.1] (2)

9.2
+
9.3

9.2 Change in mass/*Verandering in massa* = 200 – 184,8
= 15,2 g

[12.2.3] (1)

9.3 Rate of reaction = $\frac{\text{mass change}}{\text{time change}}$ /

Reaksietempo = $\frac{\text{massa verandering}}{\text{tydsverandering}}$

$$= \frac{15,2}{8} \checkmark$$

= 1,9 g·min⁻¹ ✓ (CO₂ produced /*gevorm*)

[12.2.3] (2)

9.4

OPTION 1/OPSIE 1:

mol CO₂ formed/*gevorm*:

$$n = \frac{m}{M} \checkmark = \frac{200 - 184,8}{44} \checkmark = 0,35 \text{ mol CO}_2$$

Mol CaCO₃ consumed/*verbruik*:

n(CaCO₃) = n(CO₂) = 0,35 mol ✓ (ratio/*verhouding*)

m(CaCO₃) = nM = (0,35)(100) ✓ = 35 g ✓ (34,54 g)

OPTION 2/OPSIE 2:

From balanced equation/*Uit gebalanseerde vergelyking*:

100 g CaCO₃ ✓ forms / *vorm* 44 g CO₂ ✓

m(CO₂) formed / *gevorm* = 200 – 184,8 ✓ = 15,2 g

$$m(\text{CaCO}_3) = \frac{100 \times 15,2}{44} \checkmark = 35 \text{ g (34,54 g)} \checkmark$$

[12.1.3] (5)

- 9.5 Powder - larger surface area. ✓
More effective collisions per unit time / more molecules colliding with the correct orientation. ✓
Increase in reaction rate. ✓

Poeier - groter reaksieoppervlakte. ✓
Meer effektiewe botsings per eenheidstyd / meer molekule wat met korrekte oriëntasie bots. ✓
Toename in reaksietempo. ✓

[12.1.3]

(3)
[13]

QUESTION 10/VRAAG 10

10.1

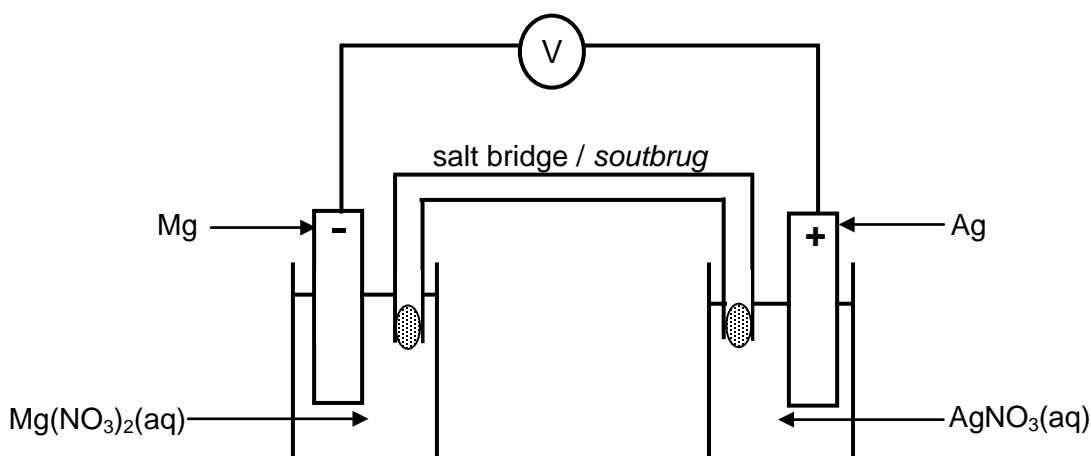

Checklist/Kontrolelys		Marks/ Punte
Criteria for diagram / <i>Kriteria vir diagram:</i>		
Both electrodes connected to voltmeter. / <i>Beide elektrodes aan voltmeter geskakel.</i>		✓
Salt bridge connecting two solutions in containers. (sketch + label) / <i>Soutbrug verbind twee oplossings in houers. (skets + benoeming)</i>		✓
Mg electrode / <i>elektrode in Mg(NO₃)₂(aq).</i> (sketch as well as labels / <i>skets sowel as benoemings</i>)		✓
Ag electrode / <i>elektrode in AgNO₃(aq).</i>		✓
Ag electrode indicated as positive and Mg electrode as negative. / <i>Ag-elektrode as positief en Mg-elektrode as negatief aangedui.</i>		✓

[12.1.1]

(5)

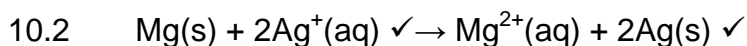

bal ✓

[12.2.3]

(3)

10.3 $E_{\text{cell}}^{\theta} = E_{\text{cathode}}^{\theta} - E_{\text{anode}}^{\theta} \checkmark / E_{\text{sel}}^{\theta} = E_{\text{katode}}^{\theta} - E_{\text{anode}}^{\theta}$
 $= 0,80 \checkmark - (-2,36) \checkmark$
 $= 3,16 \text{ V} \checkmark$

OR any other correct formula from **data sheet**
OF enige ander korrekte formule vanaf gegewensblad

OR/OF

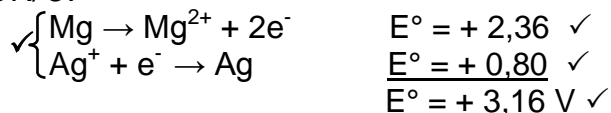

Marking rule 4.6
Nasienreël 4.6

Any other formula using unconventional abbreviations, e.g.

$E_{\text{cell}}^{\circ} = E_{\text{OA}}^{\circ} - E_{\text{RA}}^{\circ}$ followed by correct substitutions: $\frac{3}{4}$

Enige ander formule wat onkonvensionele afkortings gebruik, bv.

$E_{\text{sel}}^{\circ} = E_{\text{OM}}^{\circ} - E_{\text{RM}}^{\circ}$, gevolg deur korrekte substitusies: $\frac{3}{4}$

[12.2.3] (4)

10.4 Ensure a temperature of 25 °C \checkmark
 and solutions of concentration 1 mol·dm⁻³ \checkmark

*Verseker 'n temperatuur van 25 °C \checkmark
 en oplossing van konsentrasie 1 mol·dm⁻³ \checkmark*

[12.1.1] (2)
[20]

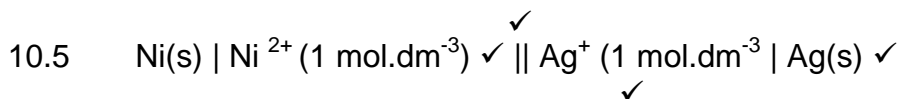

Accept /Aanvaar: $\text{Ni} \mid \text{Ni}^{2+} \checkmark \parallel \text{Ag}^{+} \mid \text{Ag} \checkmark$

NOTE: Give 1 mark for salt bridge only if complete notation is written.
LET WEL: Gee 1 punt vir die soutbrug slegs indien volledige notasie geskryf is.

[12.2.3] (3)

10.6 Option B/Opsie B \checkmark



The reaction leading to the highest emf (or potential difference) will be between the strongest reducing agent (Mg) \checkmark and the strongest oxidising agent (Ag⁺). \checkmark

Die reaksie wat tot die hoogste emk (of potensiaalverskil) lei, sal tussen die sterkste reduseermiddel (Mg) \checkmark en die sterkste oksideermiddel (Ag⁺) wees. \checkmark

[12.2.2] (3)

QUESTION 11/VRAAG 11

- 11.1 P:
 $2\text{Cl}^- \rightarrow \text{Cl}_2(\text{g}) + 2\text{e}^-$ ✓✓ OR/OF $\text{Cl}^-(\text{aq}) \rightarrow \frac{1}{2}\text{Cl}_2(\text{g}) + \text{e}^-$
Q:
 $2\text{H}_2\text{O}(\text{l}) + 2\text{e}^- \rightarrow \text{H}_2(\text{g}) + 2\text{OH}^-(\text{aq})$ ✓✓ [12.2.3] (4)
- 11.2 H₂O is a stronger oxidising agent (than Na⁺) ✓
and is more readily reduced than the Na⁺. ✓
H₂O is 'n sterker oksideermiddel as Na⁺ ✓
en word meer gereedelik gereduseer as die Na⁺. ✓ [12.2.3] (2)
- 11.3 Allows only the cation (Na⁺) to move across to the cathode compartment. / *Laat slegs die kation (Na⁺) toe om na die katode gedeelte oor te beweeg.* ✓
OR/OF
To separate the Cl⁻ ions from the OH⁻. / *Om die Cl⁻ ione van die OH⁻ ione te skei.* [12.2.3] (1)
- 11.4 Any two:
As chemical reactant in the production of:
- Medicines to cure diseases
 - Polymers
 - PVC to make plastic products e.g. pipes, insulation, handbags
 - Nylon for carpeting, clothing, etc.
 - Household products e.g. toiletries, cosmetics, CD's etc.
 - Hydrochloric acid used in building industry and swimming pools
 - Bromine used in photography
 - Solvents e.g. "tippex"
 - Solvents used for dry cleaning
 - Titanium dioxide used as white pigment in paint
 - Dyes used in textile industry
 - Pesticides used to protect crops
 - Compounds that can be used to sterilize medical equipment e.g. kidney dialysis machines, wounds and work surfaces in medical labs
 - Extraction of titanium used in aircrafts
- As disinfectant to:**
- Purify/sterilize drinking water
- As bleaching agent in the:**
- Textile industry
 - Paper industry
- Enige twee:*
As chemiese reagens in die vervaardiging van:
- *Medisyne om siektes te genees*
 - *Polimere*
 - *PVC vir die vervaardiging van plastiekprodukte bv. pype. Isolasië, handsakke ens.*
 - *Nylon vir matte, klerasie, ens.*

- *Huishoudelike produkte bv. toiletware, skoonheidsmiddels, CD's, Soutsuur vir gebruik in byvoorbeeld die bou-industrie en swembaddens*
- *Broom vir gebruik in fotografie*
- *Oplosmiddels bv. "tippex"*
- *Oplosmiddels vir gebruik in droogskoonmaak*
- *Titaandioksied gebruik as wit pigment in verf*
- *Kleurstowwe vir gebruik in die tekstielnywerheid*
- *Insekdoders gebruik om gewasse te beskerm*
- *Verbindings wat gebruik kan word om mediese toerusting te steriliseer bv. nierdialisemasjiene, wonde en werkoppervlakke in mediese laboratoriums*
- *Ekstraksie van titaan vir gebruik in vliegtuie*

As ontsmettingsmiddel om:

- *Drinkwater te suiwer/steriliseer*

As bleikmiddel in die:

- *Tekstielindustrie*
- *Papierindustrie*

[12.2.3]

(2)
[9]

QUESTION 12/VRAAG 12

- 12.1 Fractional distillation/Fraksionele distillasie [12.2.1] (1)
- 12.2 Low temperature increases the amount of NH_3 . ✓
Rate is too slow. ✓
At higher temperature NH_3 is produced at a faster rate. ✓✓
Lae temperature verhoog die hoeveelheid NH_3 . ✓
Tempo is te laag. ✓
By hoër temperature word NH_3 teen 'n vinniger tempo berei. ✓✓ [12.2.3] (4)
- 12.3 $\text{HNO}_3(\text{aq}) + \text{NH}_3(\text{g}) \checkmark \rightarrow \text{NH}_4\text{NO}_3(\text{aq}) \checkmark$ bal ✓ [12.2.3] (3)
- 12.4
- Rain washes excess of fertilisers into dams, lakes, streams and rivers causing eutrofication that leads to dead zones. ✓
Reën spoel oormatige kunsmis in damme, mere, strome en riviere in waar dit eutrofosering veroorsaak wat tot dooie sones kan lei.
 - Excessive fertiliser in the environment promotes excessive alien growth at the expense of indigenous plants. ✓
Oormaat kunsmis in die omgewing bevorder groei van indringerplante ten koste van inheemse plante.
 - Groundwater can be contaminated when excessive fertiliser seeps into it. ✓
Grondwater kan gekontamineer word deur insyfering van oormaat kunsmis.
 - Nitrates in water that can result in blue baby syndrome. ✓
Nitrate in water kan tot bloubabasindroom lei. [12.3.3] (4)
- 12.5.1 The ratio (proportion) in which nitrogen, phosphorous and potassium occurs in a certain quantity of fertiliser. ✓✓
Die verhouding (proporsie) waarin stikstof, fosfor en kalium in 'n sekere hoeveelheid kunsmis voorkom. [12.2.1] (2)
- 12.5.2 No / Nee ✓
The higher proportion of N will enhance leaf growth ✓
and less crops. ✓
Die hoër N-inhoud sal blaargroei bevorder ✓
en minder gewas/vrug ✓ [12.3.2] (3)

[17]

TOTAL SECTION / TOTAAL AFDELING B: 125

GRAND TOTAL / GROOTTOTAAL: 150